

UNCOUPLING MEMBRANES

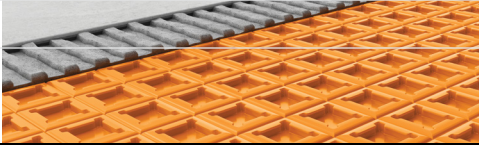

INNOVATIVE SOLUTIONS FOR CERAMIC AND STONE TILE

UNCOUPLING, WATERPROOFING, VAPOR MANAGEMENT, AND SUPPORT/LOAD DISTRIBUTION

Ceramic and stone tiles are durable, easy to maintain, and hygienic, representing the ideal surface coverings. However, today's lightweight construction methods can make the installation of hard surface coverings particularly challenging. In order to protect the integrity of the tile assembly, an underlayment that performs multiple functions is required.

Application and Function

6.1 Schluter®-DITRA and **Schluter®-DITRA-XL** are polyethylene membranes with a grid structure of square cavities, each cut back in a dovetail configuration, and an anchoring fleece laminated to the underside. The anchoring fleece is embedded in thin-set mortar to provide a mechanical bond to the substrate. Tile is installed over DITRA or DITRA-XL using the thin-bed method in such a way that the mortar becomes mechanically anchored in the square, cutback cavities of the matting.

Designed specifically for ceramic tile and dimension stone installations, DITRA and DITRA-XL serve as an uncoupling layer, waterproofing membrane, and vapor management layer that accommodates moisture from beneath the tile covering. Further, DITRA and DITRA-XL perform all these functions while still providing adequate support/load distribution for the tile covering. The combination of these four essential functions allows for the successful installation of tile over a wide range of substrates, including plywood/ OSB, concrete, gypsum, heated floors, etc.

DITRA is 1/8" (3.5 mm) thick, which minimizes tile assembly thickness and reduces transitions to lower surface coverings (e.g., carpet, engineered wood, and vinyl). DITRA allows for ceramic tile application over single-layer plywood or OSB subfloors on joists spaced up to 19.2" (488 mm) o.c. DITRA-XL is 5/16" (7 mm) thick, which permits even transitions

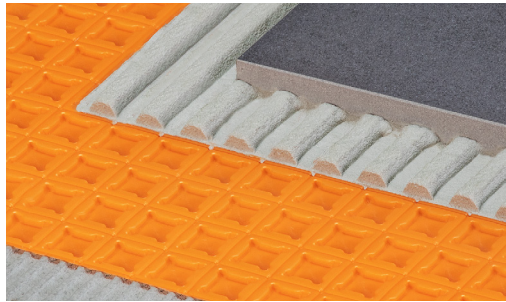

6.1 Schluter®-DITRA

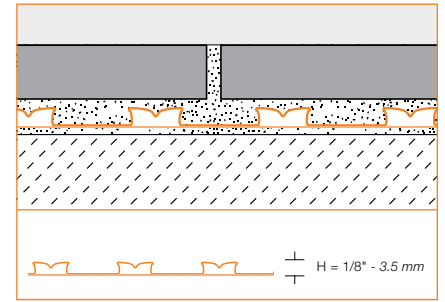

6.1 Schluter®-DITRA-PS

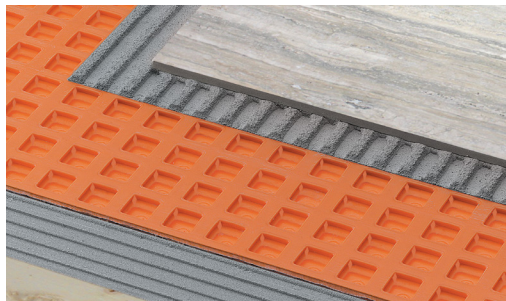
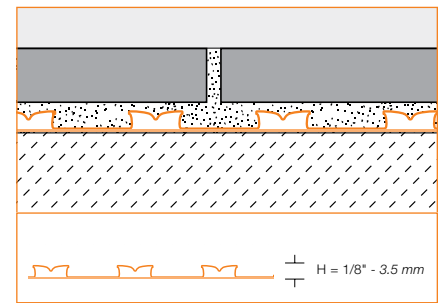

6.1 Schluter®-DITRA-XL

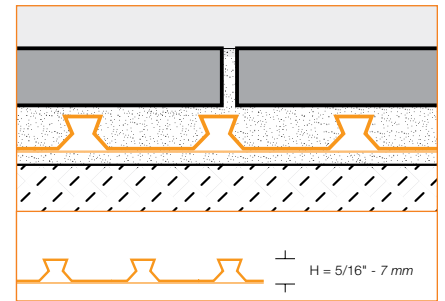

between tile and 3/4"-thick hardwood flooring. DITRA-XL allows for ceramic tile application over single-layer plywood or OSB subfloors on joists spaced up to 24" (610 mm) o.c.

DITRA-PS is a peel and stick membrane that features a pressure sensitive adhesive (PSA) to bond the membrane to the substrate, replacing the need for thin-set mortar. The -PS version offers the same core functions as DITRA.

Uncoupling

Tile has been successfully installed for thousands of years by incorporating an uncoupling layer, or forgiving shear interface, within the tile assembly. DITRA/-PS and DITRA-XL provide uncoupling through its open rib structure, which allows for in-plane movement that effectively neutralizes



the differential movement stresses between the substrate and the tile, thus eliminating the major cause of cracking and delaminating of the tiled surface.

Waterproofing

DITRA/-PS and DITRA-XL provide reliable waterproofing in interior applications. Its polyethylene composition protects the substrate from moisture penetration, which is particularly important in today's building environment where most substrates are moisture-sensitive.

For applications requiring compliance with or certification to the ANSI A118.10 American National Standard Specifications for Load Bearing, Bonded, Waterproof Membranes for Thin-Set Ceramic Tile and Dimension Stone Installation, select the DITRA membrane that is installed with thin-set mortar. Alternatively, the DITRA-PS membrane may be covered with the Schluter®-KERDI membrane, which is certified to meet ANSI A118.10.

Vapor management

The distinguishing feature of DITRA and DITRA-XL is the existence of free space created by the configured channels on the underside of the matting. The free space provides a route for excess moisture and vapor to escape from the substrate that could otherwise cause damage to the tile layer above. Thus, DITRA and DITRA-XL effectively manages moisture beneath the tile covering.

Support/load distribution

When placed on a solid foundation, columns or pillars can support tremendous loads. The same physical principle applies to DITRA/-PS and DITRA-XL installations. Column-like mortar structures are formed in the cutback cavities of the matting. Loads are transferred from the tile covering through these column-like mortar structures to the substrate. Since the matting is virtually incompressible within the tile assembly, the advantages of uncoupling are achieved without sacrificing point load distribution capabilities. The ability of DITRA/-PS and DITRA-XL installations to support and distribute heavy loads while preserving the integrity of the tiled surface has been verified through extensive laboratory and field testing, including applications exposed to vehicular traffic.

Material Properties and Areas of Application

DITRA and DITRA-XL are manufactured using high-density polyethylene (HDPE), and DITRA-PS is manufactured using polypropylene. Neither material rots and both are inert, non-toxic, and physiologically safe. The material is highly resistant to solutions containing salts, acids, and alkalis, as well as many organic solvents, alcohols, and oils. DITRA-PS features a UV sensitive pressure-sensitive adhesive that should be not be stored in places with prolonged exposure to direct sunlight. The PSA is also temperature sensitive and should be stored in a frost-free environment 41 - 86 °F (5 - 30 °C). If product is exposed to conditions outside of recommended temperature range, product shall be re-acclimated to range for a minimum of 24 hours. The PSA is not water soluble and is free of solvents. Resistance to specific stresses can be provided if concentration, temperature, and exposure time are known. DITRA/-PS and DITRA-XL are waterproof and minimize the transmission of vapor (water vapor permeance of DITRA is 0.006 perms per ASTM E96).

DITRA and DITRA-XL meet the American National Standard for Load Bearing, Bonded, Waterproof Membranes for Thin-Set Ceramic Tile and Dimension Stone Installations (ANSI A118.10), are listed by cUPC®, and are evaluated by ICC-ES (see Report Nos. ESR-2467 and PMG-1204). For copies of the above listing or report, please contact Schluter®-Systems at 800-472-4588 (USA) or 800-667-8746 (Canada) or by e-mail at info@schluter.com. Links to the listing and report can also be accessed at www.schluter.com.

Although the peel and stick version of DITRA does not comply with requirements of ANSI A118.10, it may be used in bathrooms or wet areas not requiring this specification if seams are properly treated with KERDI-BAND and KERDI accessories. If meeting ANSI A118.10 specifications is required and the peel and stick membranes is to be used, the entire area must be covered with KERDI membrane in conjunction with appropriate KERDI components

DITRA and DITRA-XL were evaluated according to the "Standard Method for the Testing and Evaluation of Volatile Organic Chemical Emissions from Indoor Sources Using Environmental Chambers, Version 1.1" for California Specification 01350 and found to comply with the VOC requirements. California Specification 01350 is referenced by various green building standards and rating systems.

Note: Due to air space within the assembly, tile coverings installed over DITRA/-PS or DITRA-XL may have a hollow sound when they are walked upon with hard shoes or tapped with a hard object.

Suitable Substrates

For complete installation guidelines and warranty criteria, please contact Schluter®-Systems at 800-472-4588 (USA) or 800-667-8746 (Canada) or by e-mail at info@schluter.com to receive a copy of the Schluter®-DITRA Installation Handbook and a step-by-step installation video. To download a PDF version of the Handbook or to view the installation video online, please visit www.schluter.com. All substrates must be clean, even, and load bearing. Bond-inhibiting surfaces must be removed prior to the application of DITRA/-PS and DITRA-XL.

Note: Type, thickness, and format of the tile or stone surface covering must be suitable for the intended application. Minimum tile format is 2" x 2" (5 x 5 cm).

Wood

All wood materials, including OSB, plywood, and framing members, are subject to expansion, contraction, bending, and deflection as a result of changes in moisture content and loading. Further, these deformations fluctuate over the life of the building structure.

DITRA/-PS and DITRA-XL's uncoupling function protects the ceramic or stone tile covering from the aforementioned deformations by neutralizing the differential movement stresses between the wood structure and the tile, thus eliminating the major cause of cracking and delaminating of the tiled surface. Therefore, DITRA/-PS and DITRA-XL can replace a second layer of plywood in most applications. Since the uncoupling function of the matting is based on its geometric configuration, the increased thickness of DITRA-XL results in increased uncoupling capacity. Thus, DITRA-XL is optimized for tile installation over bending and deflecting substrates such as plywood and OSB, including applications over single-layer plywood/OSB subfloors on joists spaced at 24" (610 mm) o.c.

Wood continually absorbs and releases moisture. The free space beneath DITRA/-PS and DITRA-XL allows the wood to breathe and provides a route for any residual moisture in the wood substrate to escape.

Since DITRA/-PS and DITRA-XL is virtually incompressible within the tile assembly, the



advantages of uncoupling are achieved without sacrificing point load distribution capabilities.

Industry standard guidelines referencing uncoupling membranes over wood substrates include methods F147 and F148 in the TCNA Handbook for Ceramic, Glass and Stone Tile Installation and method 313F (Detail D) in the Terrazzo, Tile and Marble Association of Canada (TTMAC) Specification Guide 09 30 00 Tile Installation Manual.

Note: DITRA/-PS and DITRA-XL may be installed over existing vinyl floors (no cushioned or perimeter bonded vinyl). However, various steps must be taken to ensure a successful installation. Please refer to the Schluter®-DITRA Installation Handbook for details.

Concrete

There are various challenges associated with the installation of hard surface coverings on concrete substrates. To begin, the coefficient of thermal expansion of concrete is close to twice that of ceramic tile. Additionally, tile contractors are often expected to install tile over young concrete (concrete cured less than 28 days). However, rigid surface coverings installed over young concrete are susceptible to damage as a result of shrinkage during curing. Pre-stressed/post-tensioned concrete slabs are also commonplace in today's construction environment. Although pre-stressing is used to help control deflections in concrete structures, these slabs are still subject to deformations caused by changes in moisture, temperature, and loading. Many concrete slabs on or below grade are subject to moisture migration, which can be problematic. Furthermore, these structures experience the same deformations as stated above.

DITRA/-PS and DITRA-XL's uncoupling function protects the ceramic or stone tile covering by neutralizing the differential movement stresses between the concrete substrate and the tile, thus eliminating the major cause of cracking and delaminating of the tiled surface.

DITRA/-PS and DITRA-XL's waterproofing ability not only protects the substrate from moisture and harmful substances, it also slows the drying of fresh concrete, thus reducing the chances of cracking and curling.

The free space beneath the DITRA and DITRA-XL matting provides a route for any residual moisture in the concrete slab to escape. This allows the installation of DITRA and DITRA-XL and the tile covering as soon as the slab can be walked upon. Vapor management is also essential for slabs subject to moisture migration. If installing DITRA/-PS over young concrete, there are limitations. The maximum allowable moisture vapor emission rate (MVER) of the slab is 12 lbs. per 1,000 sq. ft. (5.44 kg

per 92.9 m²) per 24 hours using an ASTM 1869 calcium chloride test kit. Do not install when the relative humidity of concrete slabs exceeds 95% (ASTM F2170).

Since DITRA/-PS and DITRA-XL is virtually incompressible within the tile assembly, the advantages of uncoupling are achieved without sacrificing point load distribution capabilities. This allows DITRA/-PS and DITRA-XL to be installed in commercial and industrial applications exposed to heavy vehicular traffic, provided the type, format, and thickness of the tile are appropriate for the application.

Industry standard guidelines referencing uncoupling membranes over concrete substrates include method F128 in the TCNA Handbook for Ceramic, Glass and Stone Tile Installation and method 311F (Details A, C and D) in the Terrazzo, Tile and Marble Association of Canada (TTMAC) Specification Guide 09 30 00 Tile Installation Manual.

Gypsum

Bonding ceramic or stone tiles directly to gypsum concrete substrates is generally considered questionable or not recommended. The challenges associated with gypsum-based underlayments include the requirement of an extended drying period before installing tile and continued sensitivity to the reintroduction of moisture throughout the life of the installation. In addition, since the coefficient of thermal expansion of gypsum concrete is substantially greater than that of ceramic tile, shear stresses caused by temperature fluctuations can result in delamination or cracking of the tile covering. This is particularly important when gypsum concrete is used as a thermal mass for radiant heated floors. With the increasing popularity of radiant heated floors, which typically utilize gypsum concrete, tile installers need a reliable installation system to address these issues.

DITRA and DITRA-XL's uncoupling function protects the ceramic or stone tile covering by neutralizing the differential movement stresses between the gypsum concrete substrate and the tile, thus eliminating the major cause of cracking and delaminating of the tiled surface. DITRA/-PS and DITRA-XL's waterproofing function prevents the reintroduction of moisture to gypsum concrete underlayments, which, if not prevented, could significantly compromise performance of the underlayment and lead to damage of the tiled surface. The residual moisture in gypsum concrete is allowed to escape through the air channels on the underside of the matting. This is particularly important since gypsum concrete must dry in order to gain strength.

Since DITRA/-PS and DITRA-XL is virtually

incompressible within the tile assembly, the advantages of uncoupling are achieved without sacrificing point load distribution capabilities.

Industry standard guidelines referencing uncoupling membranes over gypsum substrates include methods F180 and F200 in the TCNA Handbook for Ceramic, Glass and Stone Tile Installation and method 314F (Details B and F) in the Terrazzo, Tile and Marble Association of Canada (TTMAC) Specification Guide 09 30 00 Tile Installation Manual.

Heated Floors

Radiant heating is one of the fastest growing market segments in the construction industry. Unlike other surface coverings, the low thermal resistivity of ceramic and stone tiles allows them to be used in radiant heat applications without sacrificing the energy efficiency of the system. However, there are inherent challenges in combining rigid surface coverings with radiant panel heating systems. A viable installation system must address the magnified fluctuations in temperature that contribute to increased shear stresses between the heated assembly and the tile covering. The system must also limit thermal striping by promoting even heat distribution and protect the assembly from moisture, which is particularly important when gypsum concrete is used as the thermal mass. Differential movement stresses are magnified in radiant-heated floor applications because of significant temperature gradients.

DITRA/-PS and DITRA-XL's uncoupling function protects the ceramic or stone tile covering by neutralizing the differential movement stresses between the heated assembly and the tile, thus eliminating the major cause of cracking and delaminating of the tiled surface.

DITRA/-PS and DITRA-XL's waterproofing function provides simple, effective, and permanent protection for moisture-sensitive substrates, such as gypsum concrete and wood, used in heated floor applications.

The open rib structure of the DITRA/-PS and DITRA-XL matting allows the residual moisture in the substrate to escape. This is particularly important for gypsum concrete since it must dry in order to gain strength. In addition, the free space beneath the matting limits thermal striping by promoting even heat distribution throughout the assembly.

Industry standard guidelines referencing uncoupling membranes over heated floors include methods RH111, RH112, RH122 and



RH123 in the TCNA Handbook for Ceramic, Glass and Stone Tile Installation and method 314F (Details A, B, C, D, E and F) in the Terrazzo, Tile and Marble Association of Canada (TTMAC) Specification Guide 09 30 00 Tile Installation Manual.

Installation

For complete installation guidelines and warranty criteria, please contact Schluter®-Systems at 800-472-4588 (USA) or 800-667-8746 (Canada) or by e-mail at info@schluter.com to receive a copy of the Schluter®-DITRA Installation Handbook and a step-by-step installation video. To download a PDF version of the Handbook or to view the installation video online, please visit www.schluter.com. For optimal performance of peel and stick membranes with difficult-to-bond-to substrates, use Schluter®-PRIMER-PS, Schluter®-PRIMER-U, or other primer suitable for the application. Refer to Schluter-PRIMER-PS technical data sheet or contact Schluter-Systems for more information on primer applications.

Note: Type, thickness, and format of the tile or stone surface covering must be suitable for the intended application. Minimum tile format is 2" x 2" (5 cm x 5 cm).

Thin-set Facts

Schluter®-Systems offers thin-set mortars designed for use with Schluter® membranes and boards. All Schluter®-Systems' thin-set mortars, including the ALL-SET® and FAST-SET® modified varieties, can be used to set tile over Schluter®-DITRA, DITRA-HEAT, KERDI, KERDI-BOARD, etc. non absorptive substrates. If Schluter® thin-set mortars are not used, we require unmodified thin-set mortar when setting ceramic or porcelain tile over DITRA/-PS.

Question: Can ceramic tile, including porcelain tile, be set on DITRA/-PS with unmodified thin-set mortar?

Answer: YES. In fact, we recommend it.

Here's why: Portland cement-based unmodified thin-set mortars are dependent on the presence of moisture for hydration in order to gain strength. Since DITRA is impervious, it does not deprive the mortar of its moisture. This allows the cement to properly hydrate, resulting in a strong, dense bond coat. In fact, after the mortar has reached final set (usually within 24 hours), unmodified thin-set mortars achieve higher strengths when cured in continually

moist conditions.

Question: Can ceramic tile, including porcelain tile, be set on DITRA/-PS with latex-modified thin-set mortar?

Answer: In general, we DON'T recommend it.

Here's why: Latex-modified mortars must dry for the polymers to coalesce and form a hard film in order to gain strength. When sandwiched between two impervious materials such as DITRA/-PS and ceramic tile, including porcelain tile, drying takes place very slowly through the open joints in the tile covering. [According to the TCNA Handbook for Ceramic, Glass, and Stone Tile Installation, this drying period can fluctuate from 14 days to over 60 days, depending on the geographic location, the climatic conditions, and whether the installation is interior or exterior]. Therefore, extended cure times could be required before grouting if using modified thin-set mortars between DITRA and ceramic tile, including porcelain tile. If extended cure times were not observed, the results could be unpredictable.

Question: Can Schluter®-ALL-SET and Schluter®-FAST-SET modified thin-set mortars be used to set tile over Schluter boards and membranes?

Answer: Yes. All Schluter® thin-set mortars, including the ALL-SET and FAST-SET modified varieties can be used to set tile over DITRA, DITRA-HEAT, KERDI, KERDI-BOARD, etc. non absorptive substrates.

Question: How is this possible?

Answer: The key is predictability. Schluter Systems' modified thin-set mortars have been specifically formulated to set and gain strength in a timeframe that fits typical installation practice, even when sandwiched between Schluter® membranes or boards and porcelain tile. The proportions of cement, water-retention agents, polymers, and other components in the mixtures were balanced to ensure that extended dry times are not required. This was validated through both laboratory and practical testing. Now, the installer can select from either unmodified or modified thin-set mortar to install tiles within our systems according to his or her preference.

Question: Why did Schluter Systems change its position on thin-set mortar?

Answer: We haven't changed our position on thin-set mortar use within our systems. Developing our own setting materials has given us the ability to guarantee consistently positive results. And since we control the formulas, we can be sure no changes will be made that have

a negative impact on setting times and strength gain in these environments.

Question: Does this mean I can use other manufacturers' modified thin-set mortars to install tile over Schluter boards and membranes?

Answer: No. Our position on thin-set mortar use within our systems in general has not changed. We have no control over the formulation of other manufacturers' products and therefore cannot guarantee consistently positive results with their modified thin-set mortars.

Question: Can I still use other manufacturers' unmodified thin-set mortars to install tile over Schluter boards and membranes?

Answer: Yes. We still warrant the use of unmodified thin-set mortar meeting ANSI A118.1 to install tile within our systems because we have confidence in the performance of this product category. This is based on the science of cement hydration and years of positive testing and field experience.

Please note, if Schluter® thin-set mortars are used with Schluter membranes an extended system warranty is available.

Additional Notes:

Remember, the type of mortar used to apply DITRA or DITRA-XL depends on the type of substrate. The mortar must bond to the substrate and mechanically anchor the fleece on the underside of the matting. For example, bonding DITRA and DITRA-XL to wood requires latex-modified thin-set mortar. Additionally, all mortars (modified and unmodified) have an acceptable temperature range that must be observed during application and curing.

Movement Joints

DITRA/-PS and DITRA-XL do not eliminate the need for movement joints, including perimeter joints, within the tiled surface. Please refer to the Schluter®-DITRA Installation Handbook for movement joint placement guidelines.

Wood Underlayment

In some applications, adding a layer of plywood or OSB before installing DITRA/-PS or DITRA-XL and the ceramic or stone tile covering is required to reduce deflection and curvature of the sheathing between the joists. Please refer to the Schluter®-DITRA Installation Handbook for plywood/OSB underlayment installation guidelines.

Connection to Floor Drains

Schluter®-KERDI-DRAIN-F may be used to provide drainage in DITRA/-PS or DITRA-XL applications.

The KERDI waterproofing collar on KERDI-DRAIN-F is sealed to DITRA/-PS or DITRA-XL using Schluter SET®, Schluter ALL-SET®, Schluter FAST-SET®, or unmodified thin-set mortar.

Notes:

- 1) KERDI-DRAIN-F is listed by ICC-ES (Report No. PMG-1204), UPC® (File No. 4591), and CSA (File No. 211355).
- 2) DITRA and DITRA-XL meet the American National Standard Specifications for Load Bearing, Bonded, Waterproof Membranes for Thin-Set Ceramic Tile and Dimension Stone Installation (ANSI A118.10), are listed by cUPC® (File No. 4654), and are evaluated by ICC-ES (see Report Nos. ESR-2467 and PMG-1204).

For copies of the above listings or report, please contact Schluter®-Systems at 800-472-4588 (USA) or 800-667-8746 (Canada) or by e-mail at info@schluter.com. Links to the listings and report can also be accessed at www.schluter.com.

Product Item Numbers



6.1 Schluter®-DITRA Uncoupling and waterproofing membrane				
Item No.	Width	Length	Area	Thickness
DITRA 5M	3' 3" - 0.995 m	16' 8" - 5.1 m	54 ft ² - 5 m ²	1/8" - 3.5 mm
DITRA 150	3' 3" - 0.995 m	46' 3" - 14.1 m	150 ft ² - 14 m ²	1/8" - 3.5 mm
DITRA 30M	3' 3" - 0.995 m	99' 8" - 30.4 m	323 ft ² - 30 m ²	1/8" - 3.5 mm

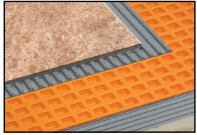

6.1 Schluter®-DITRA-XL Uncoupling and waterproofing membrane				
Item No.	Width	Length	Area	Thickness
DITRA-XL/175	3' 3" - 1 m	53' 3" - 16.25 m	175 ft ² - 16.25 m ²	5/16" - 7 mm



6.1 Schluter®-DITRA-PS Peel & stick uncoupling and waterproofing membrane					
Item No.	Format	Width	Length	Area	Thickness
DITRA-PS 110	Roll	3' 2-3/4" - 0.985 m	34' 3/4" - 10.4 m	110 ft ² - 10 m ²	1/8" - 3.5 mm
DITRA-PS 25M	Roll	3' 2-3/4" - 0.985 m	83' 4" - 25.4 m	269 ft ² - 25 m ²	1/8" - 3.5 mm
DITRA-PS MA	Sheet	3' 2-3/4" - 0.985 m	2' 5" - 0.74 m	7.75 ft ² - 0.72 m ²	1/8" - 3.5 mm



8.1 Schluter®-KERDI-BAND Waterproofing strip				
Item No.	Width	Length	Thickness	
KEBA 100/125/5M	5" - 12.5 cm	16' 5" - 5 m	4 mil	
KEBA 100/125/10M	5" - 12.5 cm	33' - 10 m	4 mil	
KEBA 100/125	5" - 12.5 cm	98' 5" - 30 m	4 mil	
KEBA 100/125/300	5" - 12.5 cm	984' 3" - 300 m	4 mil	
KEBA 100/185/5M	7-1/4" - 18.5 cm	16' 5" - 5 m	4 mil	
KEBA 100/185	7-1/4" - 18.5 cm	98' 5" - 30 m	4 mil	
KEBA 100/250/5M	10" - 25 cm	16' 5" - 5 m	4 mil	
KEBA 100/250	10" - 25 cm	98' 5" - 30 m	4 mil	



8.1 Schluter®-KERDI-FLEX Waterproofing strip for use above movement joints			
Item No.	Width	Length	Thickness
FLEX 125/5M	5" - 12.5 cm	16' 5" - 5 m	12 mil
FLEX 250/5M	10" - 25 cm	16' 5" - 5 m	12 mil
FLEX 125/30	5" - 12.5 cm	98' 5" - 30 m	12 mil
FLEX 250/30	10" - 25 cm	98' 5" - 30 m	12 mil

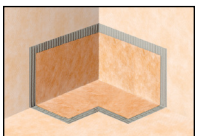
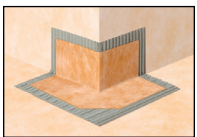

8.1 Schluter®-KERDI-KERECK-F Preformed corner		
Item No.	Thickness	Packaging
KERECK / FI 2	4 mil	2 Inside corners
KERECK / FI 10	4 mil	10 Inside corners
KERECK / FA 2	4 mil	2 Outside corners
KERECK / FA 10	4 mil	10 Outside corners

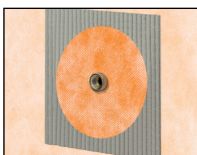

8.1 Schluter®-KERDI-KM Pipe seal			
Item No.	Dimensions	Thickness	Packaging
KM 5117/22	7" x 7" - 17 x 17 cm	4 mil	5 units

Hole diameter, $\phi = 7/8" - 22 \text{ mm}$



8.3 Schluter®-KERDI-FIX Adhesive/sealant

Item No.	Description
KERDIFIX / <i>color*</i>	Cartridge - 9.81 fl oz — 290 ml
KERDIFIX 100 G	Tube - 3.38 fl oz — 100 ml

***Color Codes**



To complete the item number, add the *color* code (e.g., KERDIFIX / **BW**).



Schluter®-DITRA-TROWEL Trowel

Item No.	Notch Size	Packaging
TRL-DIT	11/64" x 11/64" — 4.5 x 4.5 mm	1 unit



Schluter®-KERDI-TROWEL Trowel

Item No.	Notch Size	Packaging
TRL-KER	1/8" x 1/8" — 3 x 3 mm	1 unit



Schluter®-DITRA-HEAT/-DITRA-XL-TROWEL Trowel

Item No.	Notch Size	Packaging
TRL-DHXL	1/4" x 1/4" — 6 x 6 mm	1 unit



Schluter®-DITRA-ROLLER

Item No.	Width
DIRO	14-1/4" — 37 cm



Schluter®-DITRA and Schluter®-DITRA-XL Uncoupling Membrane 10-Year Limited Warranty

LIMITED WARRANTY COVERAGE: Subject to the conditions and limitations as stated in this **Schluter®-DITRA and Schluter®-DITRA-XL Uncoupling Membrane 10-Year Limited Warranty** (the “**Limited Warranty**”), Schluter Systems warrants that its Schluter®-DITRA, Schluter®-DITRA-PS and Schluter®-DITRA-XL uncoupling membranes (the “**Products**”) will be free from manufacturing defects and will perform as described in the Schluter®-DITRA Installation Handbook and Schluter®-Uncoupling Membranes Technical Data Sheet (collectively, the “**Written Materials**”) for a period of ten (10) years from the date of purchase when installed and used in accordance with the terms and conditions of the Written Materials and industry standard guidelines that are not in conflict with the Written Materials in effect at the time of installation.

For the purposes of this Limited Warranty, “**Owner**” is defined as the original end user of the property in which the Products are installed; and “**Floor Covering Assembly**” is defined to include the Products, non-reusable flooring surfaces, and applicable setting and grouting materials.

This Limited Warranty is only applicable to installations in the United States of America and Canada. Schluter Systems is not responsible or liable under any circumstances for determining the suitability of the Products for the Owner’s intended purpose. It is the responsibility of the Owner to consult with an experienced and professional installer to ensure the suitability of the Products, subfloor/substrate and all building materials in the installation and that the Written Materials are followed properly.

RESOLUTION: If the Products are installed and used in accordance with the terms and conditions as described hereinabove and such Products are proven defective within the applicable warranty term, the Owner’s exclusive remedy and the sole obligation of Schluter Systems, at its election, shall be to (a) reinstall or replace the failed portion of the Floor Covering Assembly or (b) pay an amount not to exceed the original square foot cost of the installation of the Floor Covering Assembly verified to be defective. Due to conditions beyond the control of Schluter Systems (e.g., color and shade availability, discontinuation, normal wear and tear), Schluter Systems cannot guarantee or warrant an exact match to the specific tile, stone, or other flooring materials used in the original installation. In such event, substantially similar materials may be substituted.

EXCLUSIONS FROM COVERAGE: This Limited Warranty excludes and in no event shall Schluter Systems have any liability for any indirect, special, incidental, punitive, exemplary, or consequential damages, including lost profits, arising out of or otherwise connected to the failure of the Products or Floor Covering Assembly, regardless of any strict liability or active or passive negligence of Schluter Systems, and regardless of legal theory, whether in contract, tort, extra-contractual or other. This Limited Warranty further excludes any loss or damage arising out of or otherwise connected to: acts of war, terrorism, fire, explosion, natural disaster, acts of God, any failure to comply with the Written Materials, inadequate subfloor/substrate, improper preparation or other failure of subfloor/substrate, faulty or negligent penetration of the Products or subfloor/substrate, intentional acts of destruction, structural failure, misuse of or failure to maintain the Products, normal wear and tear, scratches, dents, corrosion or discoloration (whether caused by excessive heat, chemical cleaning products, abrasive agents or otherwise), efflorescence and shading which are a natural occurrence with cementitious materials and are not considered a defective condition for the purposes of this Limited Warranty, variations of texture, color or shade from those on product samples, packaging materials or other marketing materials, or other causes unrelated to the Products (e.g. floor covering failure, excessive point loading, overvoltage). This Limited Warranty excludes exterior applications and applications utilizing glass tile or other non-approved floor coverings, unless specifically approved in writing on a case by case basis by the Schluter Systems Technical Services Director.

This Limited Warranty is conditioned and will be considered null and void and Schluter Systems will have the right to refuse any claims if: (a) the Products have been improperly stored or installed, or (b) the Products are subject to abusive or abnormal use, lack of maintenance, or used in a manner other than that for which the Products were designed or in any way contrary to the Written Materials

DISCLAIMER: There are no warranties beyond this expressed warranty as stated herein. To the extent permitted by law, all other warranties, representations or conditions, expressed or implied, are hereby disclaimed and excluded, including but not limited to the implied warranties of **MERCHANTABILITY** or **FITNESS FOR A PARTICULAR PURPOSE** (as limited to such purposes as described in the Written Materials) or arising from a course of dealing, usage of trade or otherwise by law. ANY IMPLIED WARRANTIES ARISING BY OPERATION OF LAW ARE LIMITED IN DURATION TO THE TERM OF THIS LIMITED WARRANTY. NO REPRESENTATION, PROMISE, AFFIRMATION OR STATEMENT BY ANY EMPLOYEE OR AGENT OF SCHLUTER SYSTEMS WILL BE ENFORCEABLE AGAINST SCHLUTER SYSTEMS UNLESS IT IS SPECIFICALLY INCLUDED IN THIS LIMITED WARRANTY OR AUTHORIZED IN WRITING BY THE SCHLUTER SYSTEMS TECHNICAL SERVICES DIRECTOR. This Limited Warranty is given in lieu of any other warranty, whether expressed or implied. The remedies contained herein are the only remedies available for breach of this Limited Warranty. Schluter Systems excludes and in no event shall have any liability for any indirect, special, incidental, punitive, exemplary, or consequential damages, including lost profits, arising out of or otherwise connected to failure of the Products or Floor Covering Assembly. This Limited Warranty extends only to the Owner and is not transferable or assignable unless authorized by written agreement and signed by the Schluter Systems Technical Services Director or otherwise prohibited by specific state or provincial law. This Limited Warranty gives you specific legal rights; some states and provinces do not allow disclaimers or other restrictions of implied warranties; some of the above disclaimers may not apply to you. **No changes or modifications of any terms or conditions of this Limited Warranty are permitted unless duly authorized in writing by the Schluter Systems Technical Services Director.** This Limited Warranty shall supersede and replace any and all prior oral or written warranties, agreements, or other representations made by or on behalf of Schluter Systems relative to the Products or the application of the Products and shall apply to any installation occurring on or after November 1, 2024. If the Schluter®-DITRA or Schluter®-DITRA-XL uncoupling membrane are used in conjunction with other Schluter products, a different Schluter warranty may apply. For the most current information and materials regarding Schluter Systems warranties and programs, please visit https://www.schluter.com/schluter-us/en_US/downloadfiles.

MAKING A CLAIM: To make a claim under this Limited Warranty, the Owner must provide Schluter Systems² with written notice within thirty (30) days of any alleged defect in the Products covered by this Limited Warranty, together with date and proof of purchase of such Products and/or all of its components and name and address of all installers and all invoices related to the original installation, failing which this Limited Warranty shall have no legal effect³. Schluter Systems reserves the right at its election and as a condition of this Limited Warranty to inspect the alleged failed and/or defective Products.

All U.S. Claims shall be sent to:

Schluter Systems L.P.
Attn: Warranty Claims Dept.
194 Pleasant Ridge Road
Plattsburgh, NY 12901-5841

All Canadian Claims shall be sent to:

Schluter Systems (Canada), Inc.
Attn: Warranty Claims Dept.
21100 chemin Ste-Marie
Ste-Anne-de-Bellevue, QC H9X 3Y8

¹ If there are any conflicting terms between any Written Materials, the most recently updated document shall be deemed to control.

² This Limited Warranty is limited to sales of the Products made in and intended for use in the United States and Canada. For the purposes of this Limited Warranty, Schluter Systems L.P. shall offer warranty coverage to Owners located in the United States, and Schluter Systems (Canada) Inc. shall offer warranty coverage to Owners located in Canada.

³ In the event that Owner fails to provide such required invoices relating to the original installation, Schluter Systems shall pay Owner an amount equal to the average, reasonable costs of a comparable installation. If the parties fail to agree on such amount, such dispute shall promptly, and in the first instance, be submitted: (a) if a U.S. claim, to arbitration in Clinton County, New York, in accordance with the rules of the American Arbitration Association, or (b) if a Canadian claim, in the Province of Quebec, Canada, in accordance with the ADRIC Arbitration Rules. Any outcome of such arbitration proceeding shall be final and binding upon the parties hereto.



Schluter Systems L.P. 📍 194 Pleasant Ridge Rd | Plattsburgh, NY | 12901-5841 📞 800-472-4588 📠 800-477-9783
Schluter Systems (Canada) Inc. 📍 21100 chemin Ste-Marie | Ste-Anne-de-Bellevue, QC | H9X 3Y8 📞 800-667-8746 📠 877-667-2410
🌐 [Schluter.com](https://www.schluter.com)

This technical data sheet is subject to change without notice. Please visit [Schluter.com](https://www.schluter.com) for the latest version.